

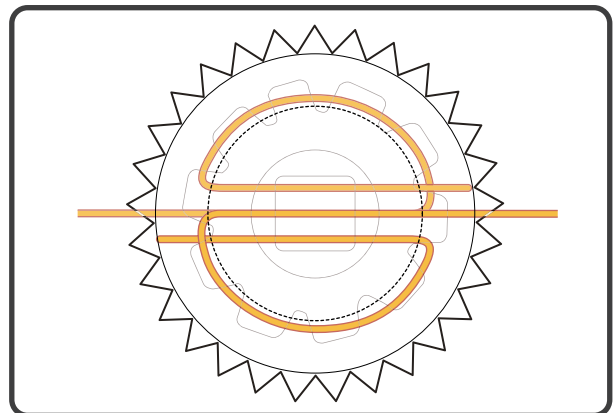

# H2/H2 COILER LACE ATTACHMENT

(1 of 3)

**HIGHPower**  
Reel Assembly

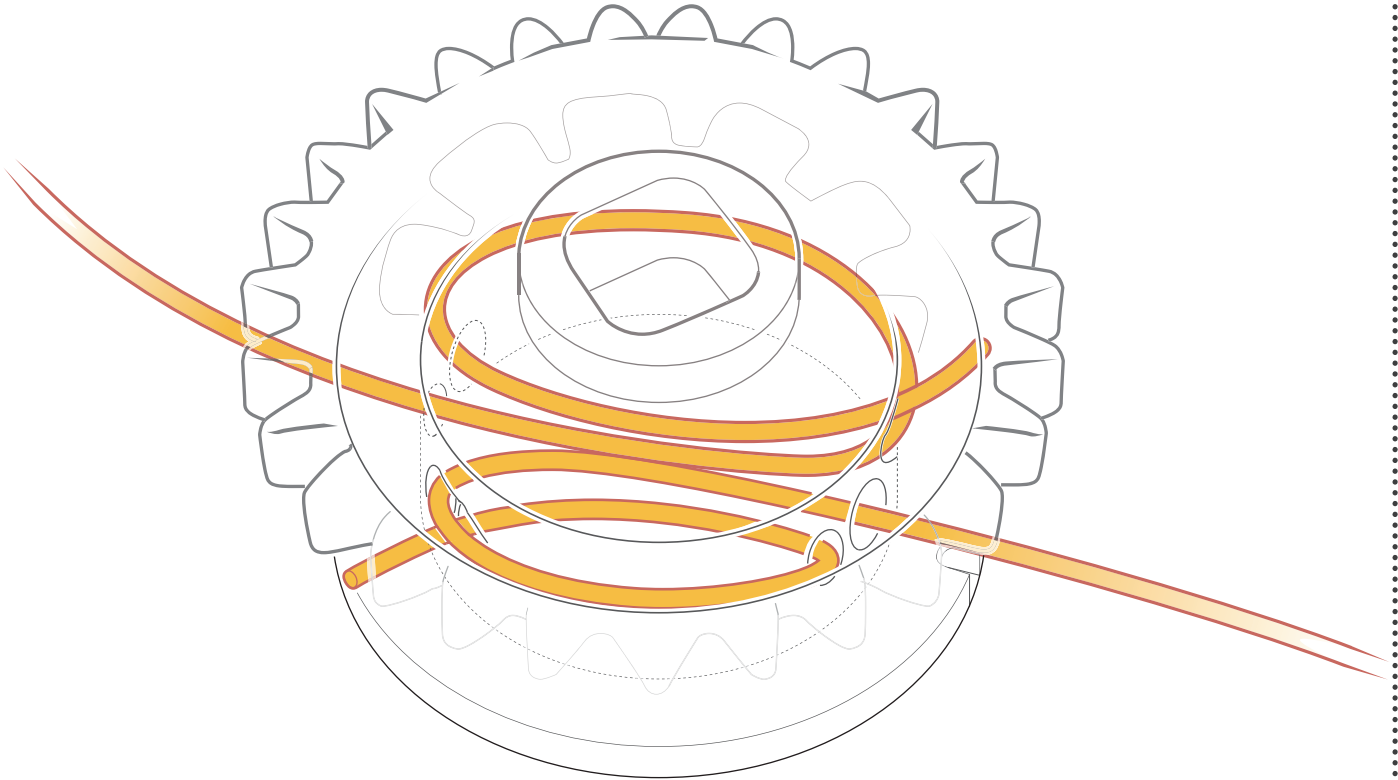

**Continued on next page** .....





# H2/H2 COILER LACE ATTACHMENT

(2 of 3)

**HIGHPower**  
Reel Assembly

**1**

**LACE THROUGH WHITE HOLE**

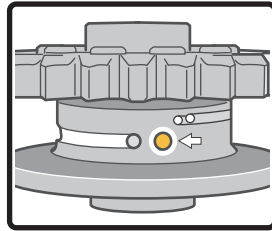
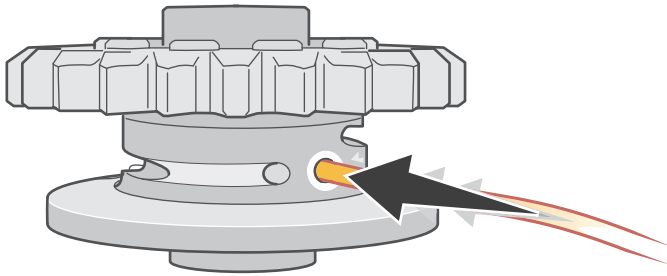

**2**

**LOOP LACE AROUND GROOVE**

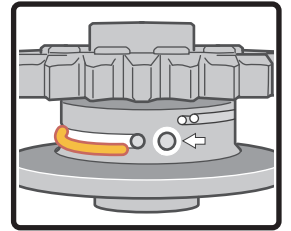
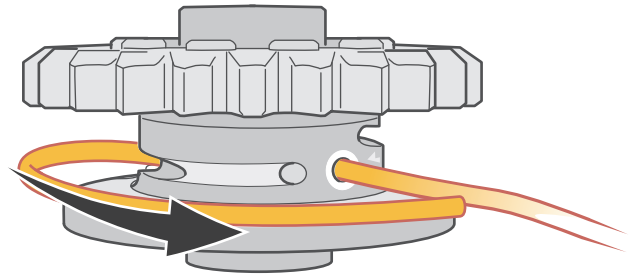

**3**

**LACE THROUGH SMALL HOLE**

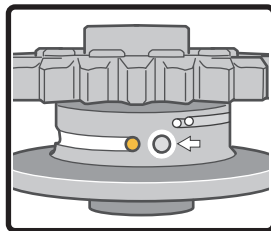
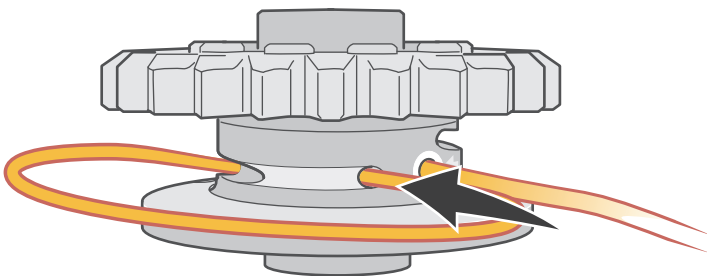

**4**

**PUSH LACE OUT OTHER SIDE**

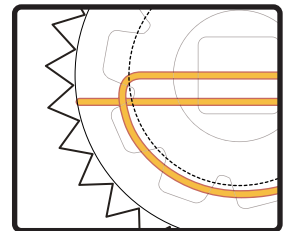
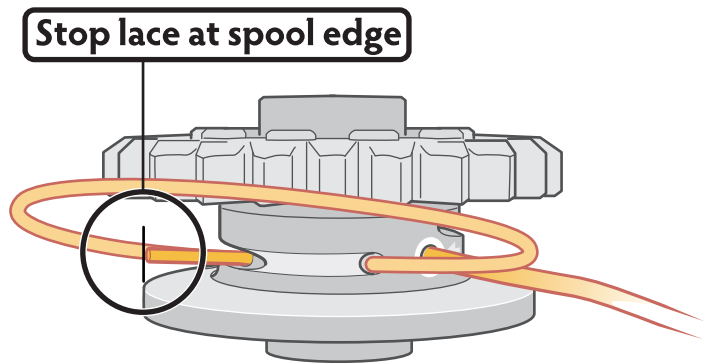

Continued on next page .....



# H2/H2 COILER LACE ATTACHMENT

(3 of 3)

**HIGHPower**  
Reel Assembly

**5**

**KEEP TAIL IN PLACE  
ON SPOOL FLANGE**

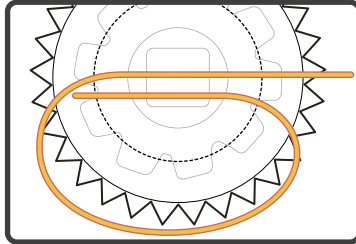
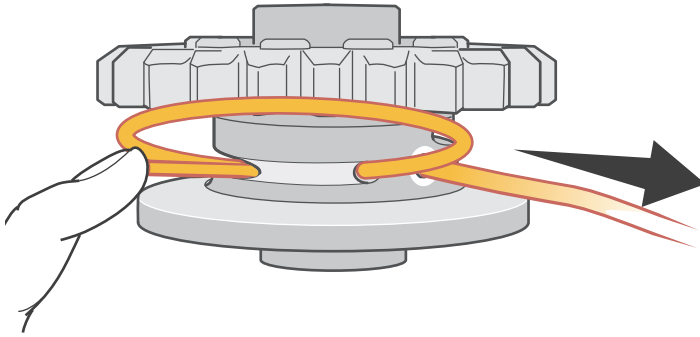

**6**

**PULL LACE TO CLOSE LOOP**

Stop lace before spool edge

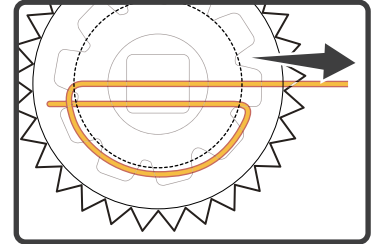
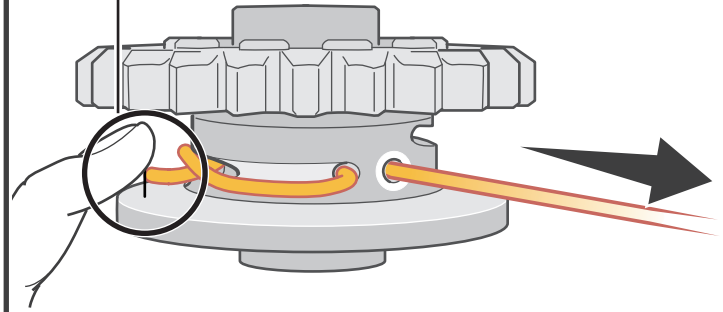

**7**

**TAIL PINCHED TO SPOOL**

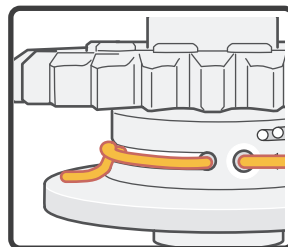
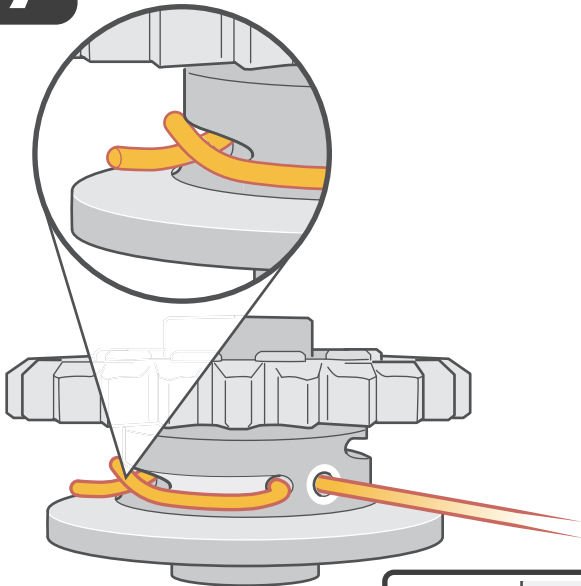

**8**

**REPEAT STEPS 1-6 FOR  
THE OTHER SIDE**

Tail pinched to spool

